

Article number: 439500032
Description: Rota-fix shaft-hub connection F32x60
Steel
Note: Self centering. Very high torque

Measures

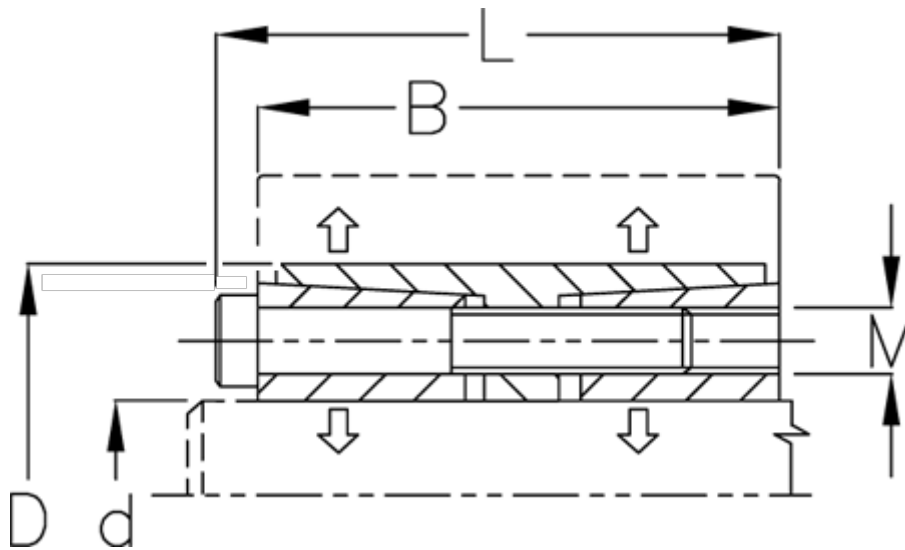

B mm	= 45
d H8 mm	= 32
D mm	= 60
Fit tolerance	= Aksel h8, Nav H8
F kN torque	= 70.0
L mm	= 51
M mm	= M6
P N/mm ² surface pressure on shaft/hub	= 100

Surface roughness	= R? ? 3.2 µm
T N m torque	= 1300
Ts N m bolt tightening torque	= 17.0